



www.sihga.com

GoFix® MS II 6,0 / 8,0 / 10,0

SICHERHEIT IM HOLZBAU GARANTIERT AUSSERGEWÖHNLICHES

MA Nr. 38812/20/1



SIHGA APP

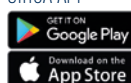

TAKE THE BEST



SIHGA® GmbH | 4694 Ohlsdorf bei Gmunden | AUSTRIA
Tel.: +43 (0) 7612 - 74 370 - 0 | Fax DW 10 | E-Mail: info@sihga.com | www.sihga.com

GoFix® MS II 6,0



GoFix® MS II 8,0



GoFix® MS II 10,0



SIHGAFIX®

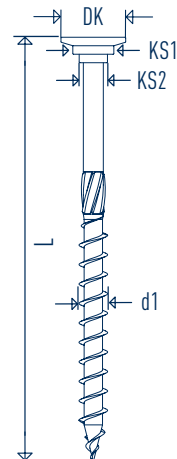
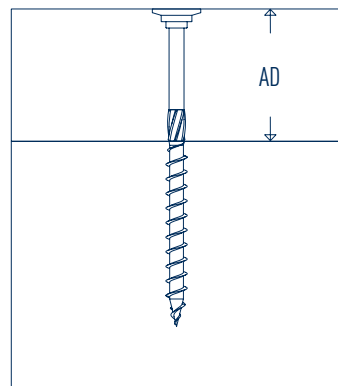

GoFix® MS II 6,0

d1	L	TX	DK	KS1	KS2	AD
6,0	70	30	13,5	8,6	6,0	28
6,0	80	30	13,5	8,6	6,0	32
6,0	90	30	13,5	8,6	6,0	36
6,0	100	30	13,5	8,6	6,0	40
6,0	120	30	13,5	8,6	6,0	50
6,0	140	30	13,5	8,6	6,0	70
6,0	160	30	13,5	8,6	6,0	90
6,0	180	30	13,5	8,6	6,0	110
6,0	200	30	13,5	8,6	6,0	130

GoFix® MS II 8,0

d1	L	TX	DK	KS1	KS2	AD
8,0	80	40	19	11,6	8	30
8,0	100	40	19	11,6	8	40
8,0	120	40	19	11,6	8	50
8,0	140	40	19	11,6	8	60
8,0	160	40	19	11,6	8	70
8,0	180	40	19	11,6	8	80
8,0	200	40	19	11,6	8	100
8,0	220	40	19	11,6	8	120
8,0	240	40	19	11,6	8	140
8,0	260	40	19	11,6	8	160

> 8,0 x 260 >>

GoFix® MS II 8,0

d1	L	TX	DK	KS1	KS2	AD
8,0	280	40	19	11,6	8	180
8,0	300	40	19	11,6	8	200
8,0	320	40	19	11,6	8	220
8,0	340	40	19	11,6	8	240
8,0	360	40	19	11,6	8	260
8,0	380	40	19	11,6	8	280
8,0	400	40	19	11,6	8	300
8,0	450	40	19	11,6	8	350
8,0	500	40	19	11,6	8	400

GoFix® MS II 10,0

d1	L	TX	DK	KS1	KS2	AD
10,0	80	50	23,0	14,4	10	30
10,0	100	50	23,0	14,4	10	40
10,0	120	50	23,0	14,4	10	50
10,0	140	50	23,0	14,4	10	60
10,0	160	50	23,0	14,4	10	70
10,0	180	50	23,0	14,4	10	80
10,0	200	50	23,0	14,4	10	100
10,0	220	50	23,0	14,4	10	120
10,0	240	50	23,0	14,4	10	140

> 10,0 x 240 >>

GoFix® MS II 10,0

d1	L	TX	DK	KS1	KS2	AD
10,0	260	50	23,0	14,4	10	160
10,0	280	50	23,0	14,4	10	180
10,0	300	50	23,0	14,4	10	200
10,0	320	50	23,0	14,4	10	220
10,0	340	50	23,0	14,4	10	240
10,0	360	50	23,0	14,4	10	260
10,0	400	50	23,0	14,4	10	300
10,0	450	50	23,0	14,4	10	350
10,0	500	50	23,0	14,4	10	400
10,0	550	50	23,0	14,4	10	450
10,0	600	50	23,0	14,4	10	500

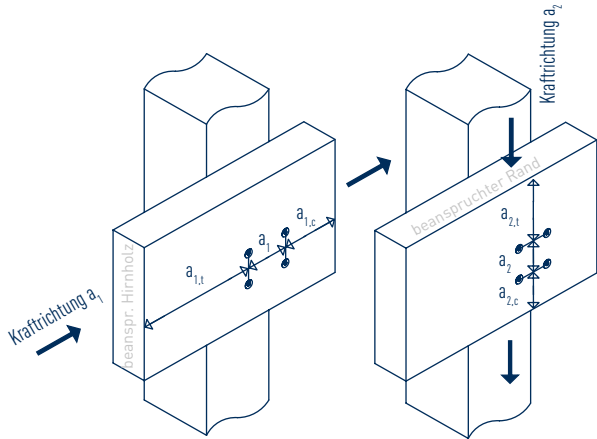
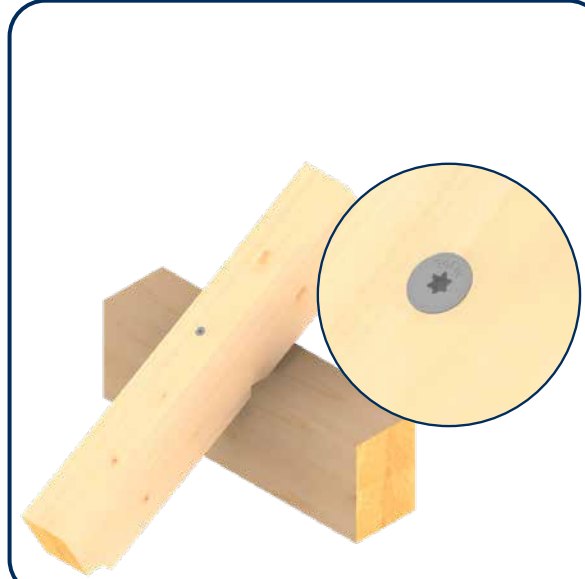
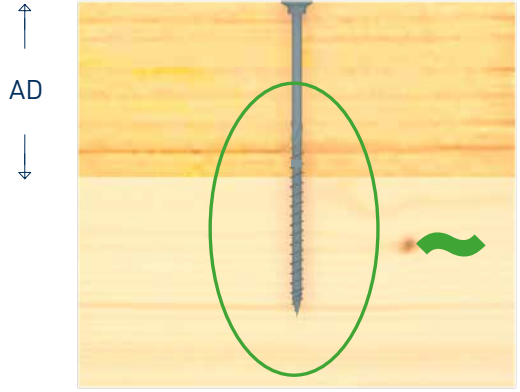
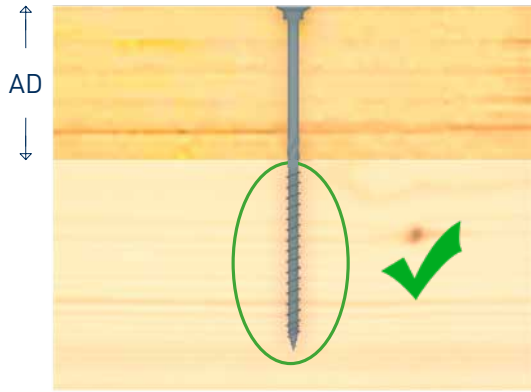
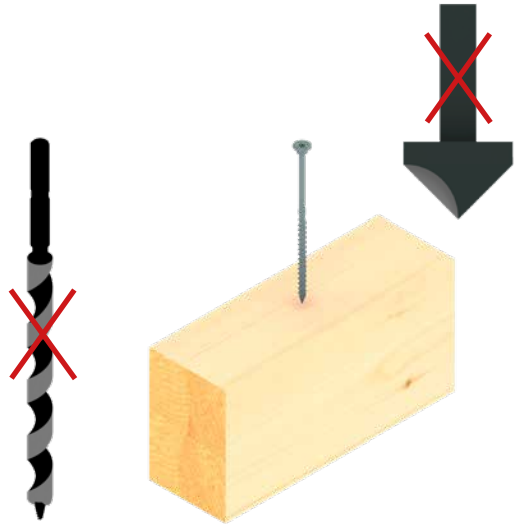

Achs- Randabstand	Abstand a	nicht vorgebohrt [mm]	vorgebohrt/ Bohrspitze [mm]
a_1	parallel zur Faser	12 d	5 d
$a_{1,t}$	beanspruchtes Hirnholz	15 d	12 d
$a_{1,c}$	unbeanspruchtes Hirnholz	10 d	7 d
a_2	rechtwinkelig zur Faser	5 d	4 d
$a_{2,t}$	beanspruchter Rand	10 d	7 d
$a_{2,r}$	unbeanspruchter Rand	5 d	3 d

d... Schraubendurchmesser

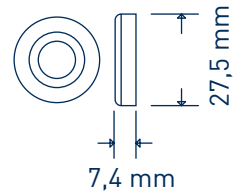

GoFix® MSZ

